

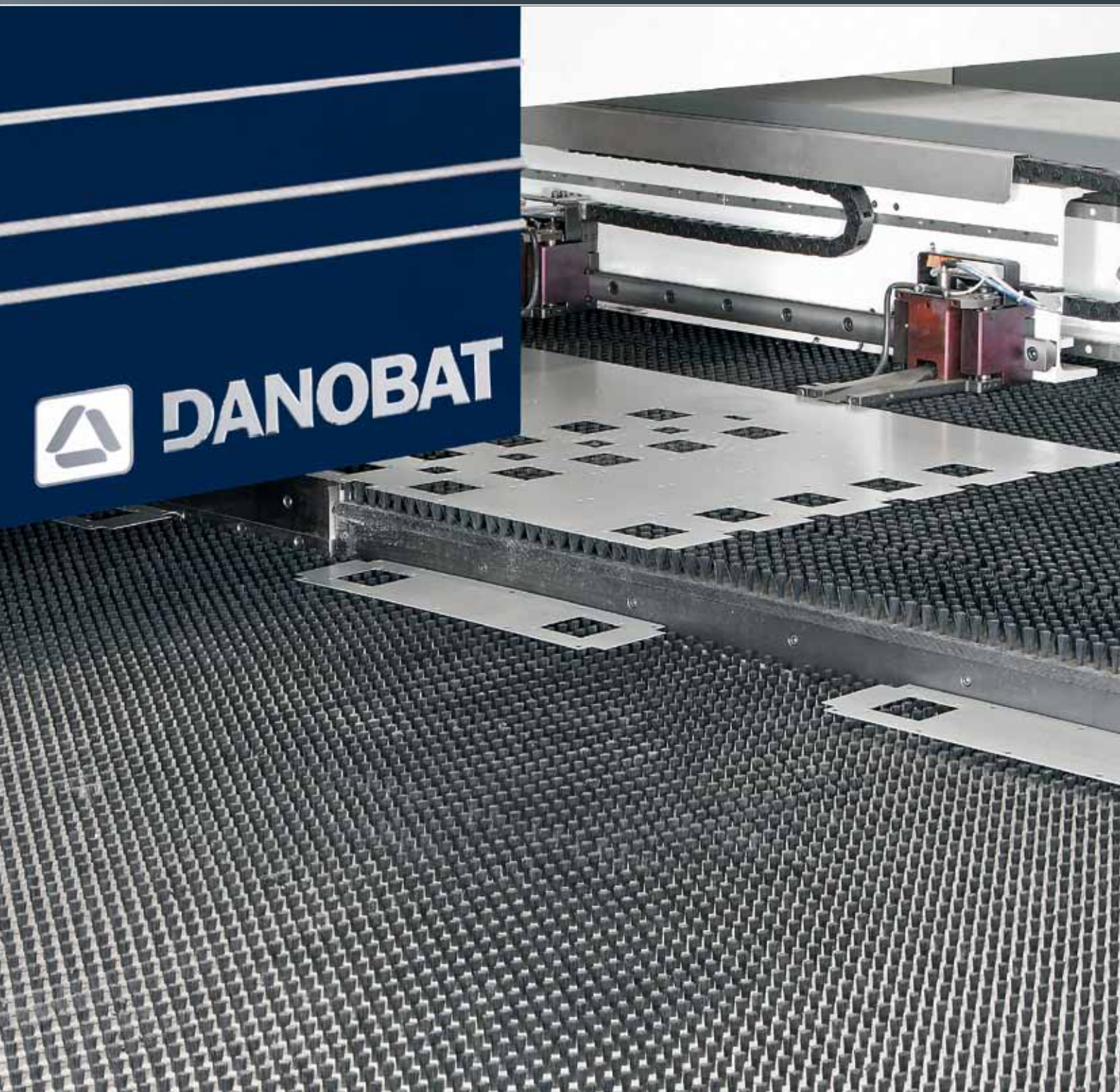

DANOBAT

CUPRA

PUNCHING + SHEARING



PRODUCTIVITY IN PROCESS INTEGRATION

DANOBAT, in its aim to reach excellence in productivity, has gone a step forward with the development of its new punch+shear combination machine.

CUPRA is the result of integrating a fully servo-electric right angle shear to our top range punching machine.

This integration of punching and shearing processes permits to start with raw material and obtain finished part in a single system, thus reducing maturation period and improving material flow.

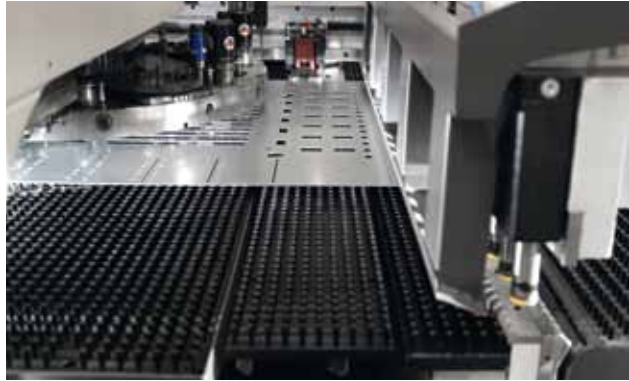

PUNCHING TECHNOLOGY



The CUPRA model is equipped with a 30 Tn servo-electric motor, achieving very high punching rates.

The machine incorporates the EASY TURRET system by DANOBAT, which improves access and reduces tool change time. Furthermore, each tool in the multi-tool becomes indexable.



SHEARING TECHNOLOGY

The right angle shear is driven by a servo-electric motor, which reaches high cutting rates.

It is perfectly complemented by the EASY TURRET system and all other benefits included in DANOBAT punching machines, which makes CUPRA the perfect solution to meet the most demanding production requirements.

Thanks to the automatic blade clearance regulation, set-up times are minimized.





EFFICIENT TECHNOLOGY



Thanks to the SAVE ENERGY system developed by DANOBAT, up to 60% power consumption reductions are achieved.

The CUPRA model also enables greater material use due to a better scrap management.

POWER OF CONSUMPTION OF HYDRAULIC VS ELECTRIC

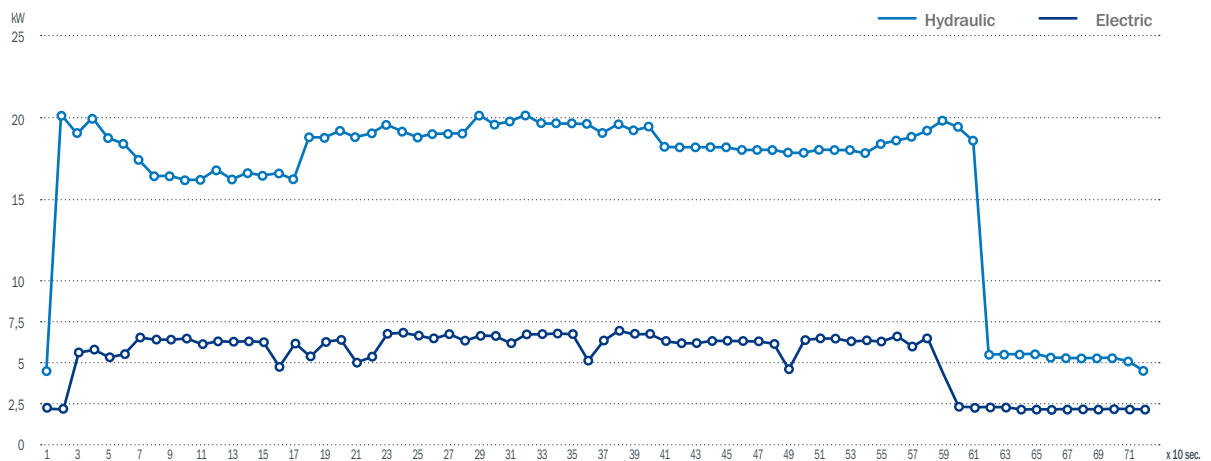

TECHNICAL SPECIFICATIONS

FEATURES		CUPRA 30	CUPRA 40
Working area without reposition	mm	1500x3000	1500x4000
Working area with reposition	mm	1500x6000	1500x8000
Hit rate in marking	hits/min	1600	1600
Hit rate at 25,4 mm centers	hits/min	480	440
Automatic sheet clamps		3	4
Maximum power consumption	KVA	7	7
Punching force	KN	300	
Shearing force	KN	150	
Maximum punching material thickness	mm	6	
Shearing material thickness	mm	0,5 - 4	
Speed of X axis movement	m/min	120	
Speed of Y axis movement	m/min	80	
N° of turret stations		Up to 43	
N° of Auto-Index tools		Up to 20	
Blade length in X	mm	800*	
Blade length in Y	mm	1500	
Drive		Servo-Electric	

* Possibility of infinite cutting in X axis through semicuts.



INTELLIGENCE AT CUSTOMER SERVICE



The application of ergonomics in machine design has also meant an advance in maintenance thanks to the incorporation of numerous mobile elements and the improvement in the access to key points.

The CUPRA model incorporates the SMART TECH system by DANOBAT, which makes the interpretation of messages easier for the customer and enables direct connection with our technical assistance service.

To allow easier maintenance for the user, the control incorporates an interactive assistance module.

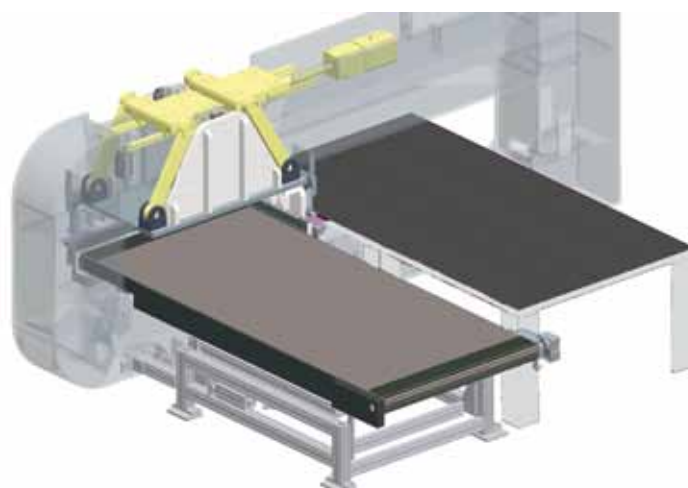

ADAPTED SOLUTION

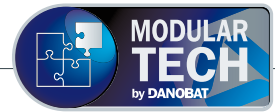

The CUPRA model is equipped as standard with an automatic double table loading system. Optionally a wide variety of accessories may be incorporated, as well as complete automation solutions:

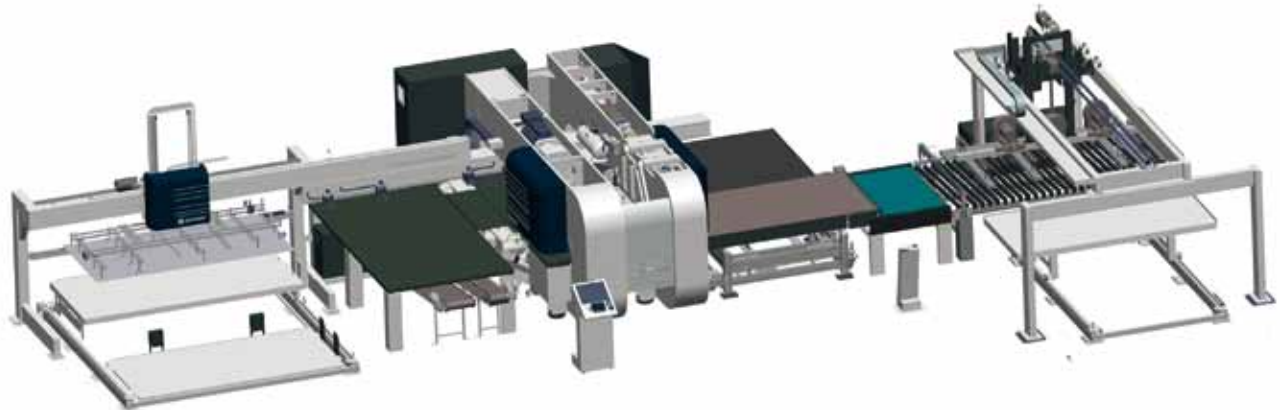

Automatic loading, separation and side stacking system of parts:

- Maximum autonomy and flexibility in production
- Reduction in production processes and manipulation
- Stacking and separation of finished parts
- More efficient use of space

Automatic sheet storage, loading, separation and lineal stacking system of parts:

- Optimum raw material management
- Maximum autonomy and flexibility in production
- Reduction in production processes and manipulation
- Complete solution for stacking and separation of finished parts

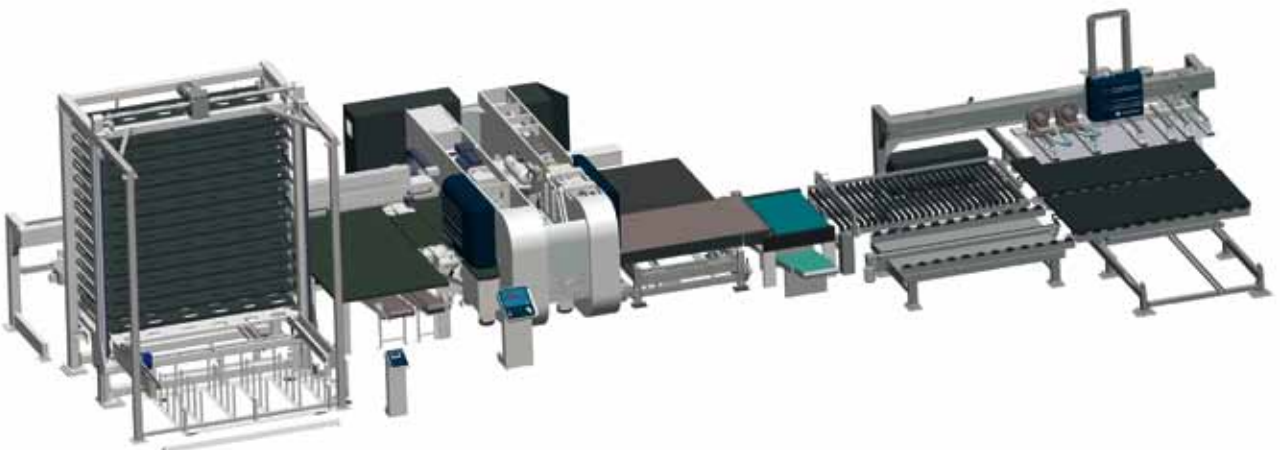



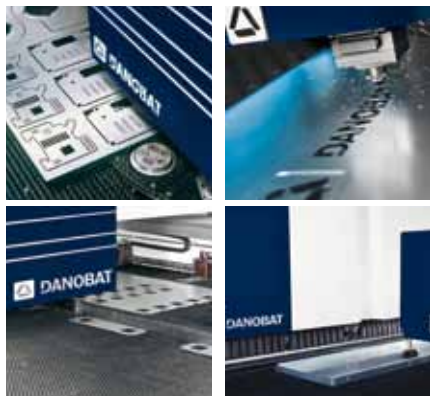



DANOBAT SHEET METAL TECHNOLOGIES



- ▶ PUNCHING
- ▶ LASER
- ▶ PUNCHING + SHEARING
- ▶ PUNCHING + LASER
- ▶ BENDING

SERVICE

We are with the customer throughout the machine life.

-  Immediate telephone response.
-  Local service assistance in each country.
-  Personal treatment.
-  Teleservice from factory.
-  Fast assistance, 24 hours.
-  Stock of parts in all countries.



MORE
INFORMATION IN

www.danobatgroup.com

If your phone has QR code reader, you can directly access to www.danobatgroup.com

DANOBATGROUP

GOITI
Apraiz kalea 1
P.O. Box 80
E-20870 ELGOIBAR (Gipuzkoa) Spain

Tel.: +34 943 74 80 23
Fax: +34 943 74 81 44
danobat@goiti.com
www.danobatsheetmetal.com
www.danobatgroup.com

